

# GRAND EFFECTS



## **Fire Candelere (Automated Operation)**

Operating and Maintenance Instructions



## Table of Contents

Section 1: Gas Requirements .....	1
Section 2: Installation .....	2
Wiring LED White Lights .....	5
Wiring for Optional Color Show .....	5
Wiring for Optional Fire Show .....	6
Section 3: Burner Setup and Adjustment .....	7
Sequence to Set Up Color LED Lights (Optional Light Show) .....	9
Section 4: Maintenance .....	11
Section 5: Operation .....	12
Operating Instructions .....	12
Control Module Diagram .....	13
Wiring Diagram .....	14
Grand Effects Warranty (1 Year Residential; 6 Months Commercial) .....	15



**WARNING!** If you smell gas, immediately take the following actions:

1. Shut off the gas to the appliance.
2. Extinguish any open flame near the unit.
3. If odor lingers, call your gas supplier.

Do not store or use any gasoline or other flammable vapors and/or liquids in the vicinity of this or any other appliance.



This manual should remain with the homeowner or parties responsible for operation.

## Section 1: Gas Requirements

Input Voltage	120 Vac / 60 Hz to Grand Effects Control Panel	
Output Voltage	24 Vac	
Gas Type	Natural	Propane
Gas Pressure (Nominal)	7" wc	11" wc
Gas Flow for Each Candelere	Normal Operation	6,500 btu/hr

**Note:** Check with your gas supplier to verify gas flows and pressures available at the location of your installation. In many cases utility companies will install larger meters at no charge to accommodate larger flows.

## Section 2: Installation

**⚠ WARNING!** This unit is for outdoor use only.  
Recommended CSA/AGA Clearances: Sides 4 ft / Top 6 ft

Do not install near any combustibles such as wood structures, fuels, clothing, fabrics, or dry vegetation.

Install candelere out of the way of pedestrian traffic.

Installation must be performed by a licensed contractor. All aspects of installation must conform to local or national codes, or in the absence of codes, with Natural Fuel Gas Code ANZI Z223.1.

The control panel and approved gas valve must be located where they can be easily accessible so that the gas can be shut off quickly in case of an emergency.

1. Install the burner control panel and gas piping as shown in Figure 1: Natural Gas, Figure 2: Propane Gas, or Figure 3: Commercial Installation. Gas lines must be clean and free from any dirt, debris, or contamination.

**Note:** Propane piping is different than natural gas piping (shown in Figure 1 and Figure 2).

2. The gas piping must be installed underground using approved pipe.

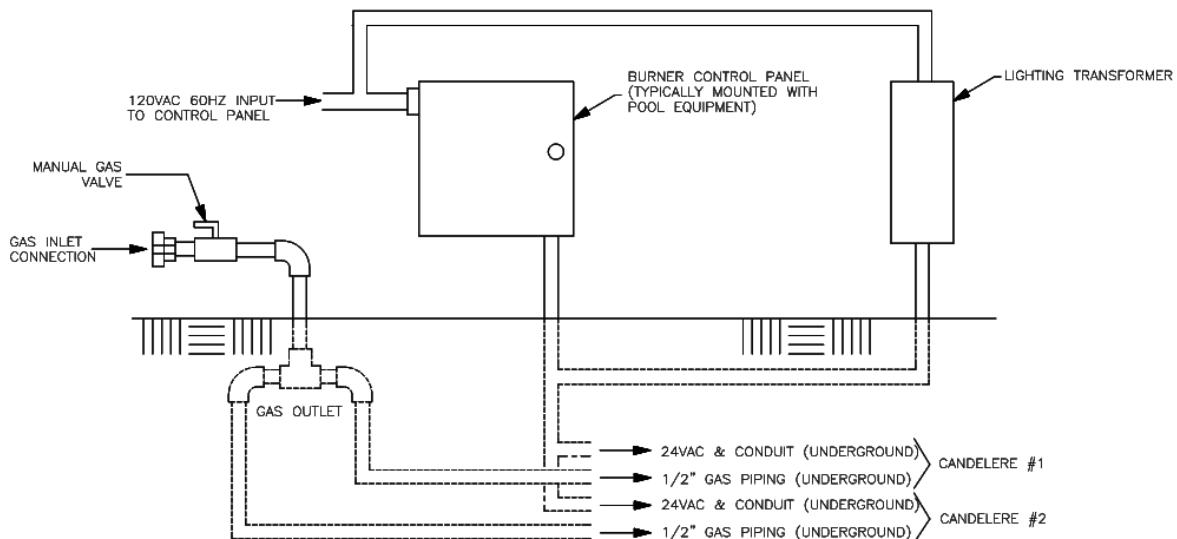

**Figure 1: Natural Gas**

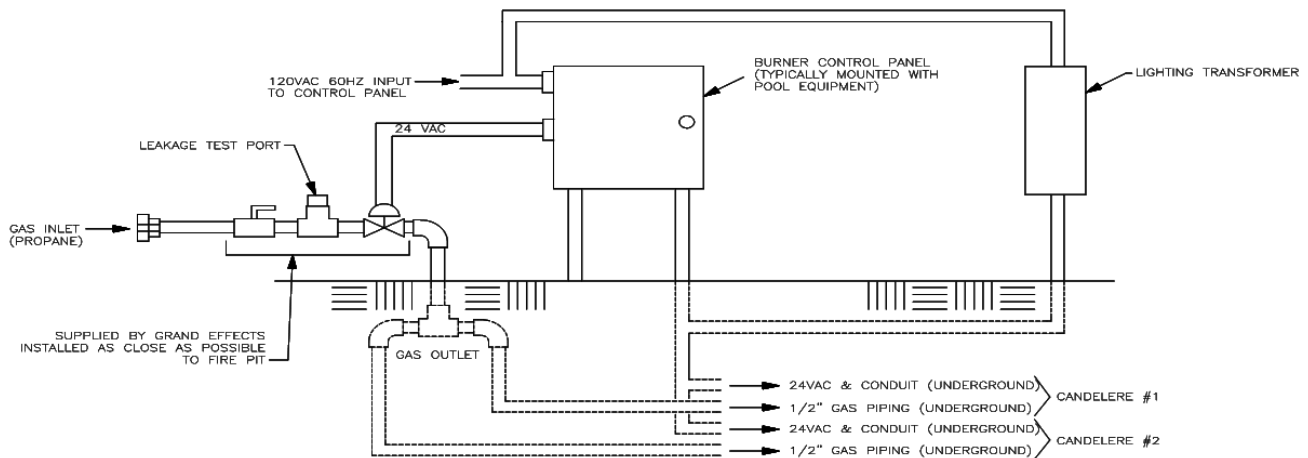

**Figure 2: Propane Gas**

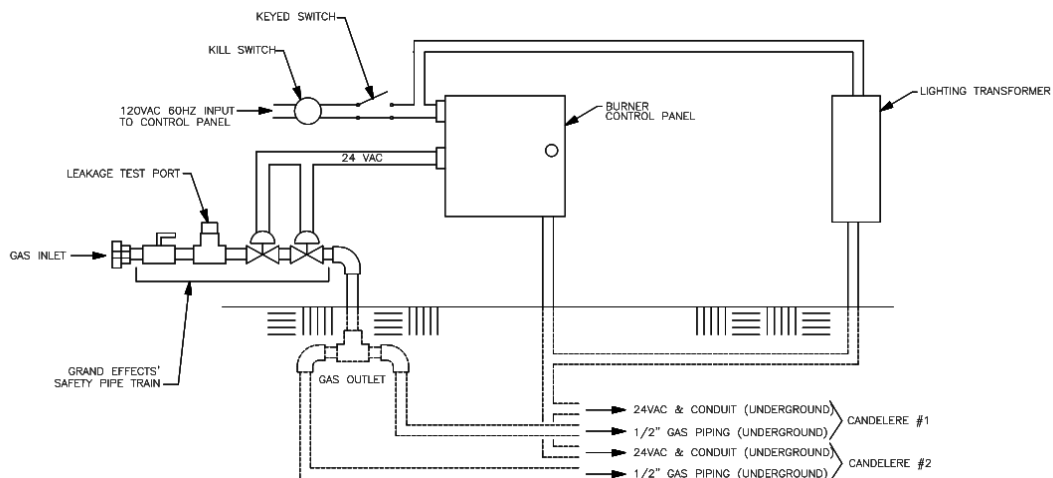

**Figure 3: Commercial Installation**

3. Most installations will require 3/8"-1/2" approved gas line to each candelere location as shown in Figure 4. Required pipe size will be determined by the length of the run and should be determined by a gas expert.
4. At each candelere, install a 90° gas pipe elbow on the gas line for proper installation of a gas hose. Do not kink or make a tight radius bend on the gas hose.

**Note:** The gas and electrical connection at each burner must be located at the center of each burner. The connections must be installed as shown in Figure 4.

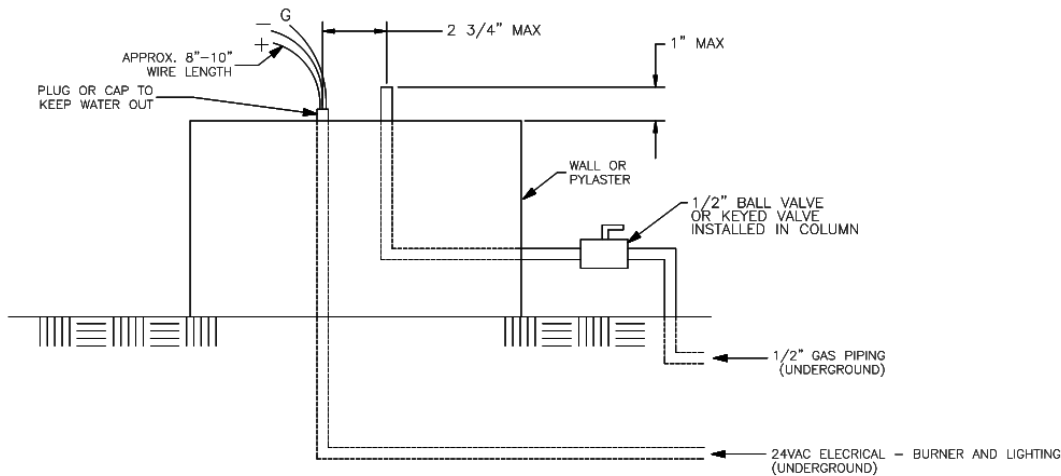

**Figure 4: Piping**

5. Install low voltage wiring (12, 14, or 16 ga. 24VAC) underground between the control panel and each candelere. Wire per Grand Effects wiring diagram. 120v source into the control panel can come from any 120v source, including auxiliary relay from the pool controller or home system. Typically, the pool controller is the device that turns the unit on and off. If a pool controller is not available, Grand Effects can provide a hand held remote system or an electrician can wire a decorative switch for on/off control up stream of the Grand Effects Control Panel.

**Note:** Wiring candeleres in a daisy chain configuration is also acceptable. The standard candelere requires three wires (+, -, g) from the control panel or daisy chain configuration. When wiring for the fire show option, an additional three wires from the control panel are required to operate the high position solenoid.

6. Maintain good piping practice by keeping pipe length and elbows to a minimum to eliminate unnecessary pressure drops. Corrugated flex gas lines should not be used as they will make a loud whistling noise.
7. Gas piping and electric should be centered in the middle of the column or center of each candelere.

**Important:** Height of the gas piping is critical and should be no higher than 3/4".

8. Install 90° pipe elbow and gas hose at the gas connection as shown in Figure 5.
9. On commercial installations, it is recommended to install a keyed switch and kill switch located in close proximity and in visible sight of feature or features. The keyed and kill switches are supplied by others.

10. Install supplied flexible gas hose to 90° pipe elbow and gas connection at the burner assembly as seen in Figure 5. Ensure that gas connection is tight with no leaks.

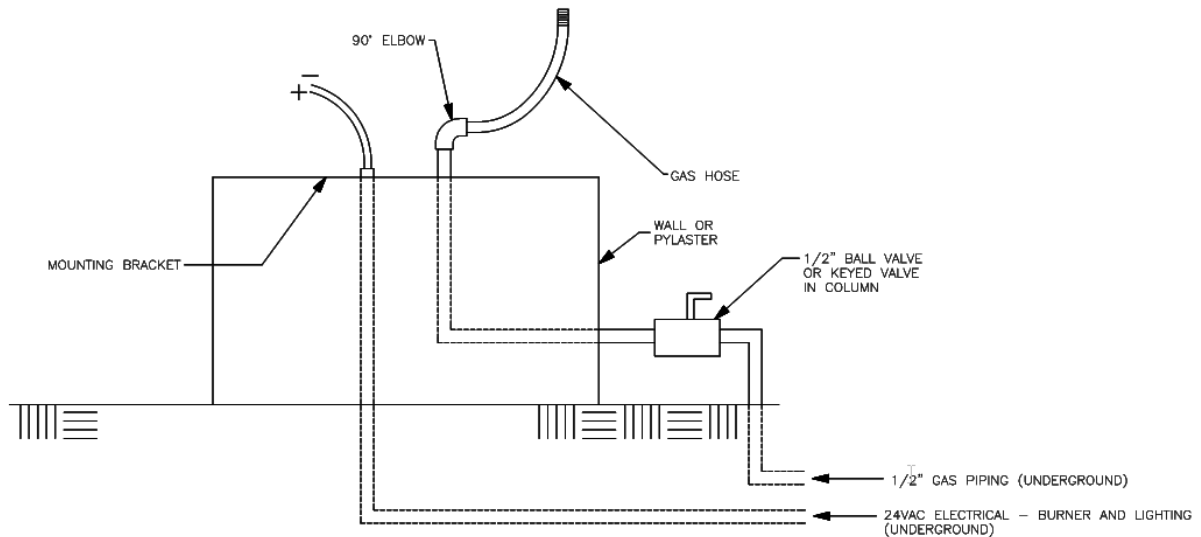

Figure 5

## Wiring LED White Lights

Low voltage wiring to the LED light in the candelere (12, 14, or 16 ga 12v DC) can be installed in the same conduit as the same low voltage electrical for the burner assembly. The light transformer supplied by Grand Effects can be installed next to the control panel. The light transformer requires a 120VAC input source.

The same pool controller auxiliary relay to send 120v to the burner assembly can also be wired to send 120v to the transformer, powering up the LED lights in the candelere and the burner system at the same time (see Figure 1). Using water proof wire nuts, connect wires at LED white lights. Polarity is not important.

## Wiring for Optional Color Show

The light transformer supplied by Grand Effects can be installed next to the Grand Effects Control Panel. The transformer requires a 120 VAC input source. The same pool controller auxiliary relay to send 120v to the burner assembly can also be wired to send 120v to the transformer, powering up the color LED lights in the candelere and the burner system at the same time (see Figure 1).

The required wiring from the pool controller to the candelere should be a minimum 3-conductor 14awg wire with a maximum length of 150 ft. If there is more than one candelere, run a 3-conductor wire from the first to the second candelere, from the

second to the third, and so on. Six maximum tested candelere are allowed in this daisy chain configuration. The maximum length allowed between each candelere is 50 ft.

**Note:** Connect positive (+) to positive (+) and negative (-) to negative (-) and (S) to (S) between transformer and first candelere and between each candelere.

### **Wiring for Optional Fire Show**

When wiring for the fire show option, an additional three wires from the burner control panel are required to operate the high position solenoid. You can run the additional three wires with the other low voltage wires.



## Section 3: Burner Setup and Adjustment

1. At each candelere, turn the switch located in the manual gas valve to the “Off” position.
2. With 120VAC coming into the control panel, turn the burner switch “On.”
3. At each candelere, check that the spark electrode is arcing from the ignitor button to the pilot. You should be able to hear and see the electrode spark. If there is no spark, make sure that the candelere is receiving 24VAC from the control panel.
4. At each candelere, open the manual gas valve.
5. In the control panel, turn the burner switch to the “On” position.
6. After all candeleres have been lit, they can be adjusted for flame size.
7. The height of the flame can be adjusted at each burner by opening or closing the manual gas valve located at the gas inlet on each candelere. The approximate flame height should be 5”-8” tall.

**Important:** At this time, the corresponding candeleres should ignite. If the burner does not light, it may be a result of air in the gas line. If this happens, carefully purge the air from the gas line by disconnecting the gas hose from the burner assembly. The end of the gas hose should be outside of the burner when purging air from the gas line.

**⚠ CAUTION!** When purging air from a propane system, disconnect wires going to the burner assemblies (terminals X1/X2) located in Grand Effects control panel. There should be no power at the candeleres when purging propane. The propane adder valve should remain wired and energized when purging. After purging is complete, make sure the area is vented and free from build-up gas. Reinstall wires at X1/X2 terminals, thus providing power to candeleres.

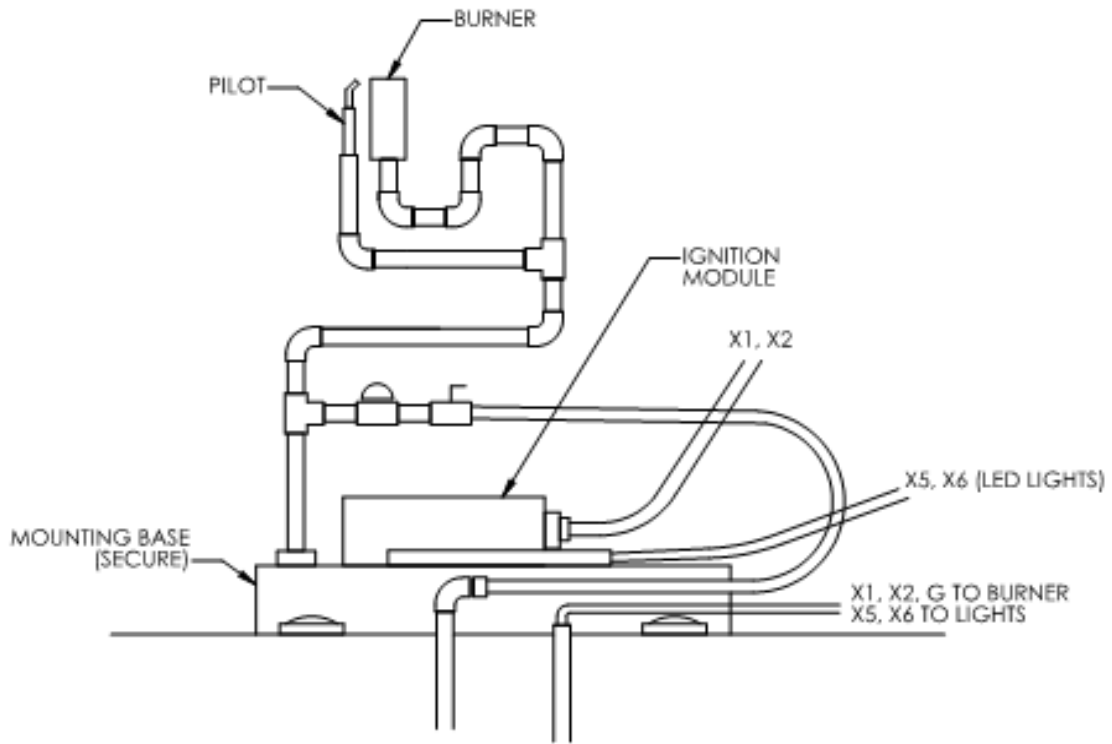

Figure 5

## Sequence to Set Up Color LED Lights (Optional Light Show)

There are 7 static colors and 4 color change modes to choose from.

Static colors:

- Red
- Yellow
- Green
- Aqua
- Blue
- Magenta
- White

Color changing modes:

- Very fast 1 second cycling
- Fast 5 second cycling
- Slow 1 minute cycling
- Very slow 20 minute cycling

**Note:** The color change mode rotates between the first 6 static colors, except for white.

**Important:** Located in the LED light transformer control panel is a round rocker switch. This is not a system power the “On/Off” switch. This round rocker switch is used to switch between the 7 static colors and 4 changing modes. System “On/Off” is accomplished through the pool controller or other “On/Off” device that is connected to the incoming 120V supply.

1. Power on the system.
2. Switch the control rocker switch in the transformer panel to the “Off” position for 5 seconds, then switch to the “On” position. All lights should flash red and then stay in the static red color mode. This is the first of the 11 programmed modes in the controller.

**Note:** Steps 1 and 2 are used for initial system setup or if candelere get out of color sequence.

3. To switch through the 7 static colors and 4 color change modes, switch the control rocker switch to the “Off” position for 1 second, and then switch back to the “On” position. Each “Off” to “On” sequence will signal the controller to change to the next color or color change speed. Leave the switch in the “On” position when the desired static color or color change speed is achieved.

**Important:** Switching the control rocker too fast by less than 1 second will cause the lights to get out of sequence. If at any time the lights get out of sequence, repeat steps 1 and 2.

## Section 4: Maintenance

Periodically clean the burner assembly with a wet cloth or cleaning solution to remove carbon build-up.

Frequency of the cleaning will depend on usage.

Periodically inspect the underside of the burner assembly for any signs of excessive temperatures.

Check that all gas connections are tight.

The units should be operated on a regular basis, especially after a rain. The burner assembly will not work in snow and ice conditions. It is recommended to winterize the unit by covering candelere and temporarily removing the candelere burner system for the winter season. The burner should not be operated in high wind conditions. High winds can limit the cooling air required for cooling of the burner assembly and cause over heating of the electronics.

Gas must be securely shut off while not in use.

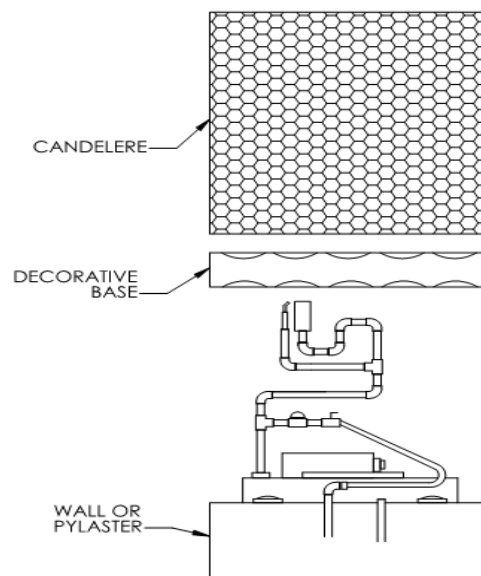

Figure 6

Note: If any problems are present, consult a licensed heating Specialist or call Grand Effects.

## Section 5: Operation

**⚠ WARNING!** This unit is for outdoor use only.

**Important:** Do not operate in rainy or windy conditions with winds in excess of 15 mph.

For your safety:

- If you smell gas, shut off the gas valve immediately.
- Extinguish any open flame.
- If odor continues, immediately call your gas supplier.
- Do not store or use gasoline or other flammable vapors and/or liquids in the vicinity of this appliance.
- Do not leave flame on while unsupervised.
- Do not operate in windy or rainy conditions. If this is done, the unit will cycle on and off automatically.
- Unit should be operated only by a responsible adult.
- When in use, an open flame is present; therefore, use with extreme care and at your own risk.
- Before any inspection of the unit, always turn off power and gas supply at the control panel.
- If you experience problems with this unit, call Grand Effects or a licensed heating professional. All work on this unit must be performed by a licensed heating professional.

**⚠ CAUTION!** Before you turn on the Grand Effects System, make sure that features are clear of people, animals, or any objects that are combustible.

### Operating Instructions

To turn unit "On":

1. Open manual gas valve.
2. Turn burner switch "On."

To turn unit "Off":

1. Turn burner switch "Off."
2. Close manual gas valve.

**Note:** If burner fails to light, turn corresponding burner switch in the control panel to the "Off" position, and then to the "On" position. This will initiate a new trial for ignition.

# Control Module Diagram

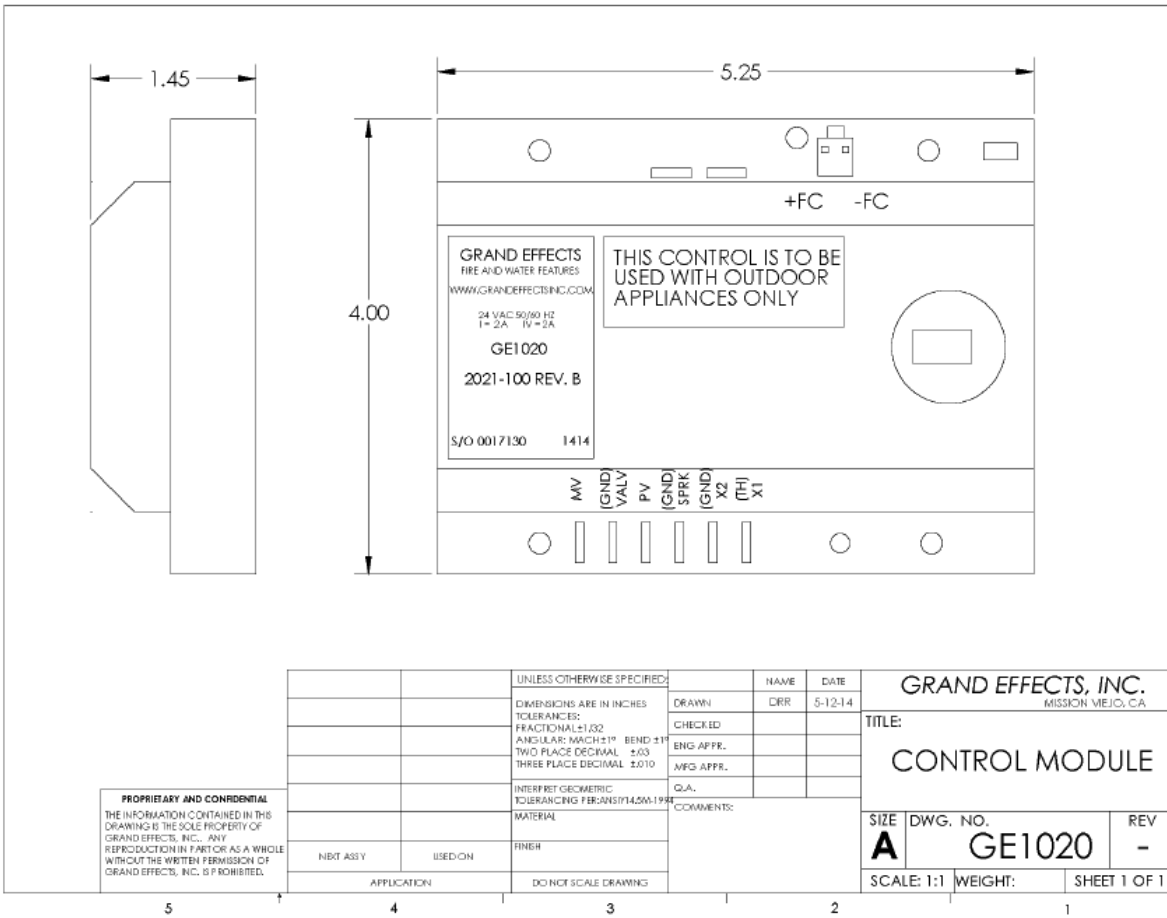

# Wiring Diagram

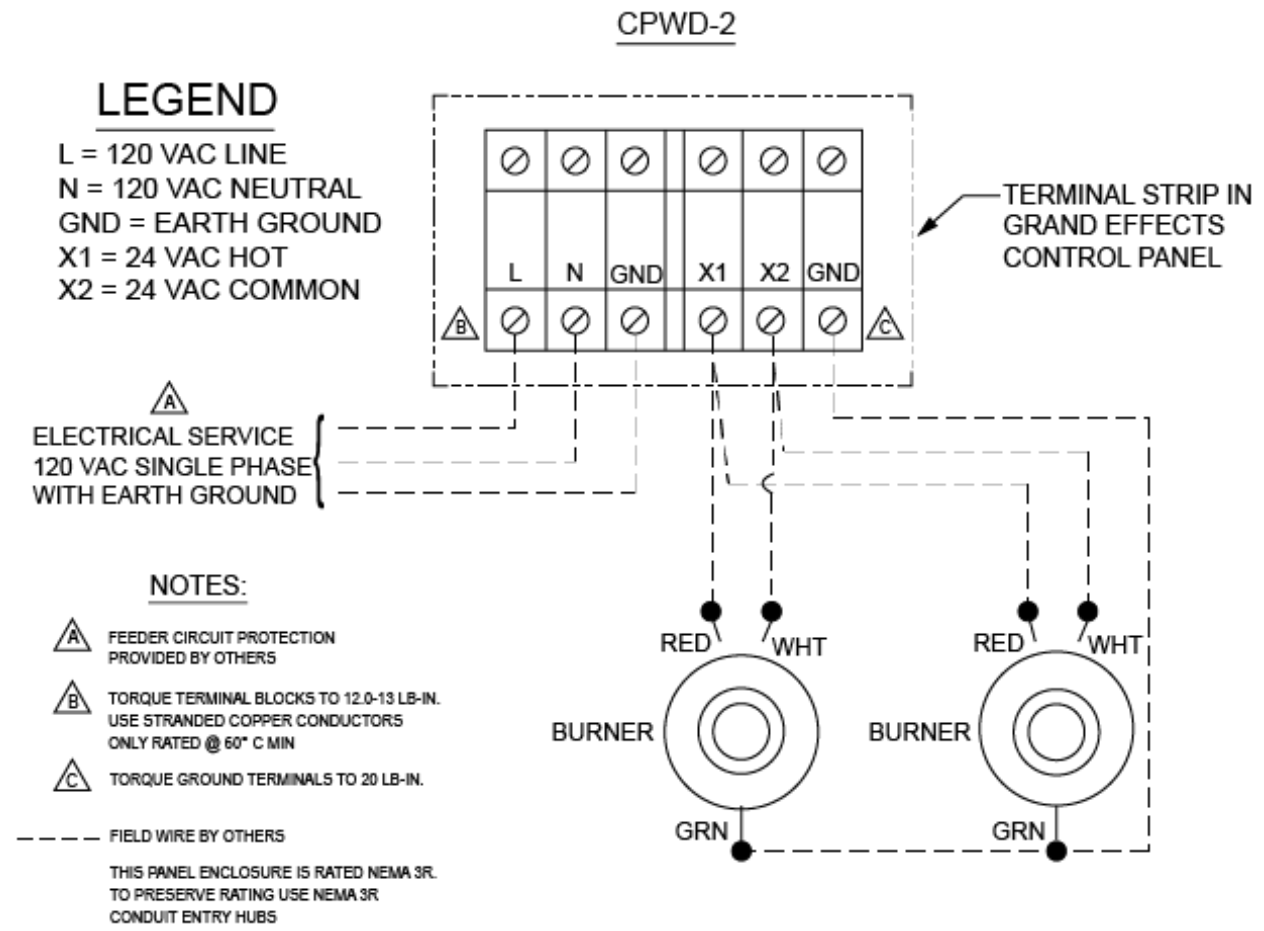



## **Grand Effects Warranty (1 Year Residential; 6 Months Commercial)**

Grand Effects will attempt to repair, at its expense, any unit, which in normal use, has proven to be defective in workmanship or material, provided that the Buyer provides or arranges for the return of the product prepaid to Grand Effects with proof of product date of delivery to the end user of the product and provides Grand Effects with reasonable opportunity to verify the alleged defect by inspection, which shall not be more than 15 days after receipt by Grand Effects. If the unit is deemed defective and cannot be repaired, Grand Effects will replace. Grand Effects will not be responsible for any asserted defect, which has resulted from misuse, abuse, repair or alteration. Under no circumstances will Grand Effects be liable for incidental or consequential damage resulting from defective products. This warranty is Grand Effects' sole warranty and sets forth the exclusive remedy, with respect to defective products, all other warranties, expressed or implied, whether of merchantability, fitness for purpose or otherwise, are expressly disclaimed by Grand Effects. Grand Effects is not responsible for any injury or mishap related to misuse, abuse or lack of judgment choosing fire display locations.

Contact us at:



GRAND EFFECTS

18 Technology Dr. #110  
Irvine, CA 92618  
Office: (949) 697-5270  
Fax: (949) 625-8027  
E-mail: [info@grandeffectsinc.com](mailto:info@grandeffectsinc.com)