

GRAND EFFECTS



Fire Bowls (Manual Operation)

Operating and Maintenance Instructions



Table of Contents

Section 1: Gas Requirements	1
Section 2: Installation	2
Section 3: Burner Setup and Adjustment	5
Section 4: Maintenance.....	6
Section 5: Operation.....	7
Operating Instructions.....	7
Grand Effects Warranty (1 Year Residential; 6 Months Commercial)	8

-  **WARNING!** If you smell gas, immediately take the following actions:
1. Shut off the gas to the appliance.
 2. Extinguish any open flame near the unit.
 3. If odor lingers, call your gas supplier.

Do not store or use any gasoline or other flammable vapors and/or liquids in the vicinity of this or any other appliance.



This manual should remain with the homeowner or parties responsible for operation.

Section 1: Gas Requirements

Gas Type	Natural	Propane
Gas Pressure (Nominal)	7" wc	11" wc
Gas Flow	1 Bowl System	60,000-80,000 btu/hr

Note: Check with your gas supplier to verify gas flows and pressures available at the location of your installation. In many cases utility companies will install larger meters at no charge to accommodate larger flows.

Section 2: Installation

⚠ WARNING! This unit is for outdoor use only.

Do not install near any combustibles such as wood structures, fuels, clothing, fabrics, or dry vegetation.

Install bowls out of the way of pedestrian traffic.

Installation shall be performed by a licensed contractor. All aspects of installation must conform to local or national codes, or in the absence of codes, with Natural Fuel Gas Code ANZI Z223.1.

An approved gas valve or keyed valve shall be installed upstream of the unit and located in an accessible area that is within 5ft from the Grand Effects Unit.

The approved gas valve must be located where it can be easily accessible so that the gas can be shut off quickly in case of an emergency.

1. Install the Grand Effects Unit as shown in Figure 1, Figure 2, and Figure 4. Figure 3 is an optional configuration to catch dirty run-off water.
2. The gas piping must be installed underground between each fire bowl, as shown in Figure 1.

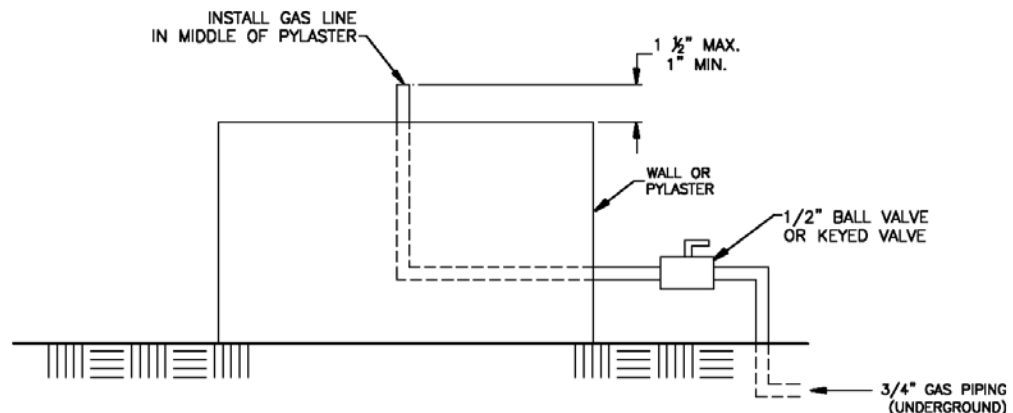
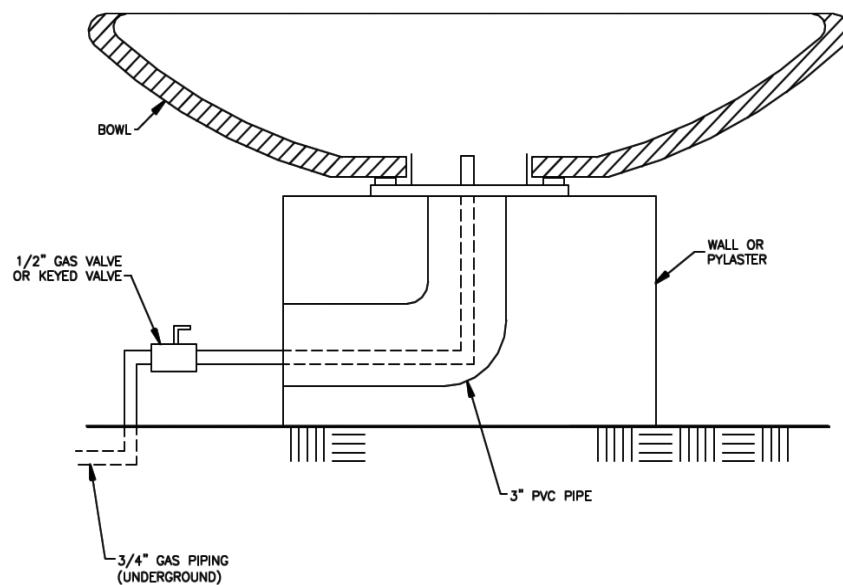
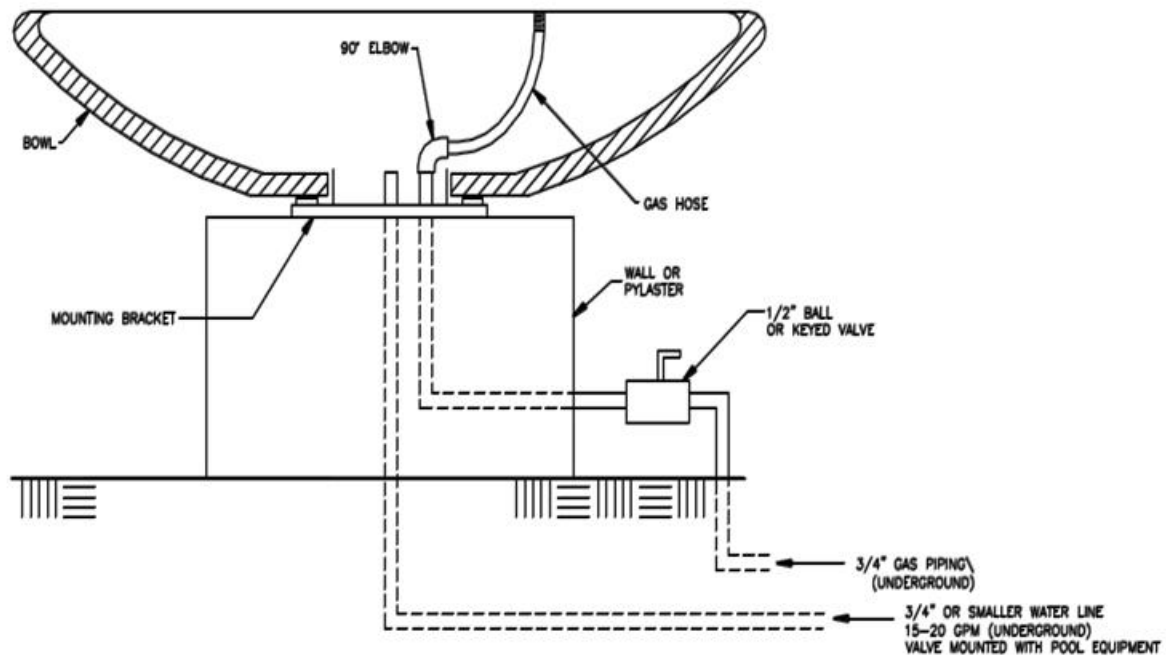

Figure 1



3. The piping must be reduced to 1/2" NPT or larger at each bowl, as shown in Figure 2.
4. Maintain good piping practice by keeping pipe length and elbows to a minimum to eliminate unnecessary pressure drops. Corrugated flex gas lines should not be used.

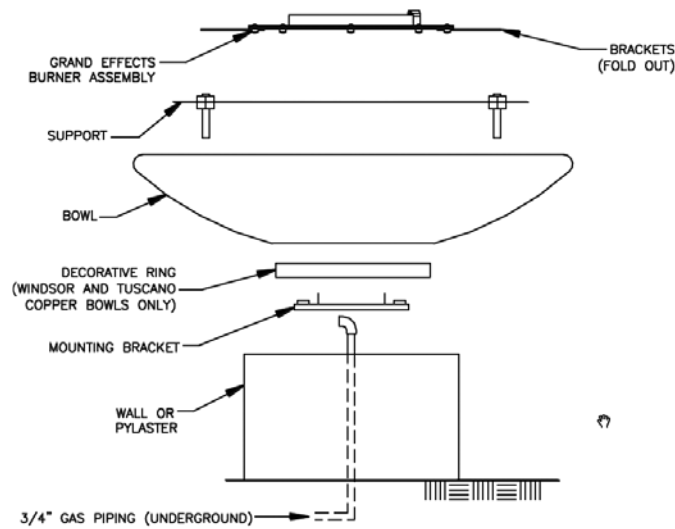

Figure 4

5. Gas should be centered in the middle of the column.
6. Customer-supplied bowls should be similar in size to Grand Effects bowls: 27" min. ID x 9" min. Inner height with a 4" hole in the bottom of the bowl.
7. On commercial installations, it is recommended to install a keyed switch and kill switch located in close proximity and in visible sight of feature or features. The keyed and kill switches are supplied by Grand Effects.
8. Center the bowl on top of the mounting bracket. The bowl should rest on top of the three spacers located on the mounting bracket. Using a hammer, carefully bend over the metal prongs to secure the bowl.
9. Install a 3/8" 90° pipe elbow and gas hose at the gas connection as shown in Figure 2.
10. Connect gas hose to the bowl.
11. With all gas connections tight, position the burner assembly so that it sits level in the bowl. Rotate as required so that the gas hose rests in a compact position.

Important: The mounting bracket must be installed for proper cooling of the bowl. Warranty is voided if the mounting bracket is not installed. Do not kink or make sharp radius on the metal gas hose. Do not come straight up with the gas hose. As shown in Figure 2, a 90° gas pipe elbow must be installed on the gas line for proper installation of the gas hose. The product warranty is voided if it is not installed with an elbow as shown in Figure 4.

Section 3: Burner Setup and Adjustment

Note: Each burner should have a flame height of approximately 12" – 15" from the top of the bowl.

1. The height of the flame can be adjusted at each burner by opening or closing the ½" gas valve or keyed valve as shown in Figure 3.

Each burner should be adjusted as required so that the flame size at each bowl is similar in appearance to each other.

2. After all burners have been adjusted, make sure that the burner assembly is repositioned so that it is sitting level in each bowl.
3. Install decorative rock or glass on top of the "burner support" and burner assembly. Larger lava rock is recommended (2" - 4" in size). It will work better than smaller rock.

Note: Do not use glass with propane installations. (If you use glass with natural gas, you will need to lay down a pre-cut stainless mesh screen to prevent glass from falling through.)

Important: Do not use fire glass with propane installations.

 **CAUTION!** Use only approved decorative media to cover the burner assembly. Lava and tumbled lava/ceramic stone and fire glass are all accepted media. However, use caution when in the immediate area, as pieces may pop or explode when exposed to heat or when wet and exposed to heat.

Section 4: Maintenance

Periodically clean the burner assembly and bowl with a wet cloth or cleaning solution to remove carbon build-up.

Frequency of the cleaning will depend on usage.

Frequently inspect the gap between the base of the bowl and the mounting bracket. It should be kept free of dirt and debris that may restrict cooling air and drainage (see Figure 3).

Periodically inspect the underside of the burner assembly for any signs of excessive temperatures.

Check that all gas connections are tight.

The burner assembly should be covered and protected from snow and ice. The burner should not be operated in high wind conditions.

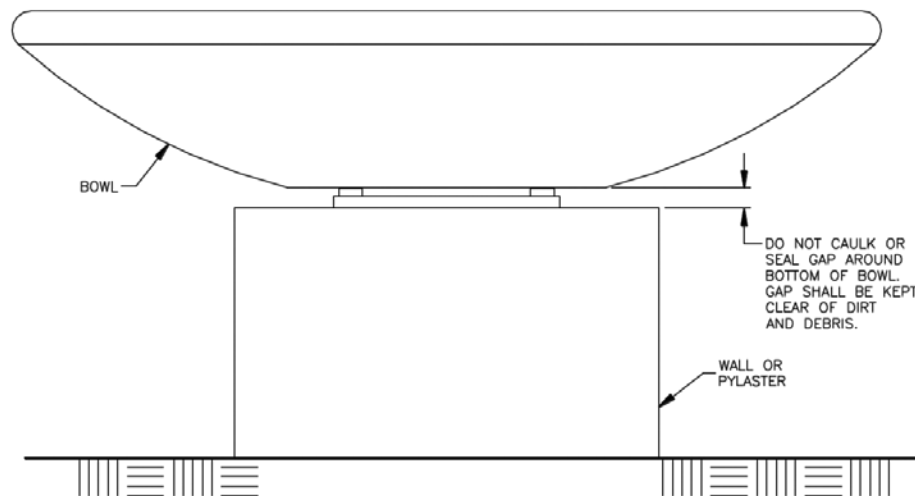

Figure 5: Maintenance

Note: If any problems are present, consult a licensed heating specialist or call Grand Effects.

Section 5: Operation

⚠ WARNING! This unit is for outdoor use only.

For your safety:

- If you smell gas, shut off the gas valve immediately.
- Extinguish any open flame.
- If odor continues, immediately call your gas supplier.
- Do not store or use gasoline or other flammable vapors and/or liquids in the vicinity of this appliance.
- Do not leave flame on while unsupervised.
- Do not operate in windy or rainy conditions. If this is done, the unit will cycle on and off automatically.
- Unit should be operated only by a responsible adult.
- When in use, an open flame is present; therefore, use with extreme care and at your own risk.
- Before any inspection of the unit, always turn off power and gas supply.
- If you experience problems with this unit, call Grand Effects or a licensed heating professional. All work on this unit must be performed by a licensed heating professional.

⚠ CAUTION! Before you turn on the Grand Effects System, make sure that features are clear of people, animals, or any objects that are combustible.

Operating Instructions

With the gas valve in the closed position, check the Grand Effects Unit for any gas smell or indication of a gas leak. If you smell gas or see evidence of a gas leak, do not operate the unit. Immediately call your utility gas supplier to inspect the unit.

If there is no evidence of a gas leak, crack open the gas valve and immediately light the burner with an approved lighting device.

The height of the flame can be adjusted by opening or closing the ball valve or keyed valve.

To turn the Unit “OFF,” close the gas valve to the fully closed position.

Grand Effects Warranty (1 Year Residential; 6 Months Commercial)

Grand Effects will attempt to repair, at its expense, any unit, which in normal use, has proven to be defective in workmanship or material, provided that the Buyer provides or arranges for the return of the product prepaid to Grand Effects with proof of product date of delivery to the end user of the product and provides Grand Effects with reasonable opportunity to verify the alleged defect by inspection, which shall not be more than 15 days after receipt by Grand Effects. If the unit is deemed defective and cannot be repaired, Grand Effects will replace. Grand Effects will not be responsible for any asserted defect, which has resulted from misuse, abuse, repair or alteration. Under no circumstances will Grand Effects be liable for incidental or consequential damage resulting from defective products. This warranty is Grand Effects' sole warranty and sets forth the exclusive remedy, with respect to defective products, all other warranties, expressed or implied, whether of merchantability, fitness for purpose or otherwise, are expressly disclaimed by Grand Effects. Grand Effects is not responsible for any injury or mishap related to misuse, abuse or lack of judgment choosing fire display locations.



Contact us at:

GRAND EFFECTS

18 Technology Dr. #110
Irvine, CA 92618
Office: (949) 697-5270
Fax: (949) 625-8027
E-mail: info@grandeffectsinc.com